

Brandgasventilator F300  
7,5 kW  
24.000 m<sup>3</sup>/h  
400 Pa ext.

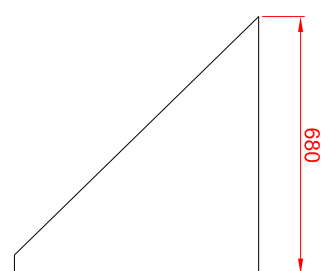

Auslassstutzen mit Schutzgitter

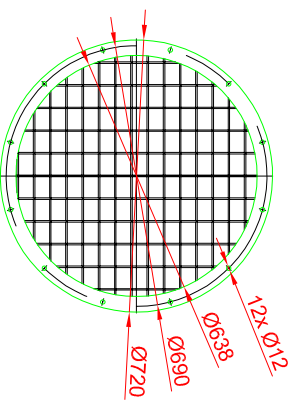
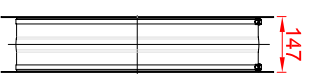
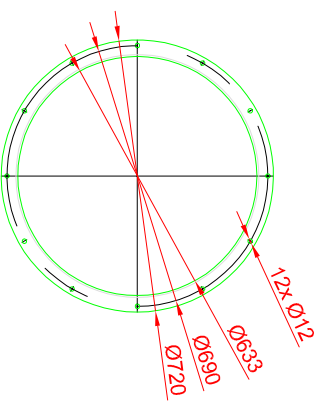

elastische Verbindung

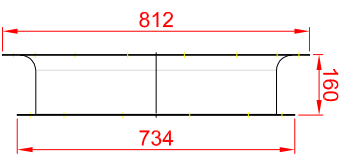
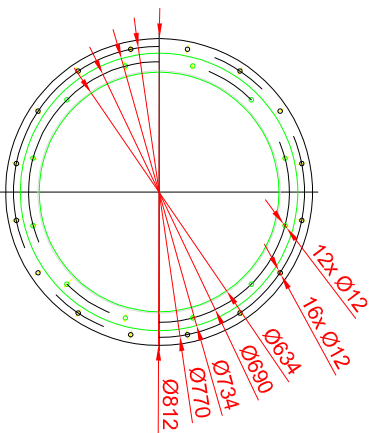

Einströmdüse

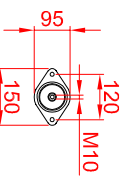

Schwingungsdämpfer

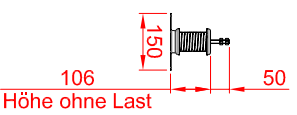

Gesamtgewicht ~ 183 Kg

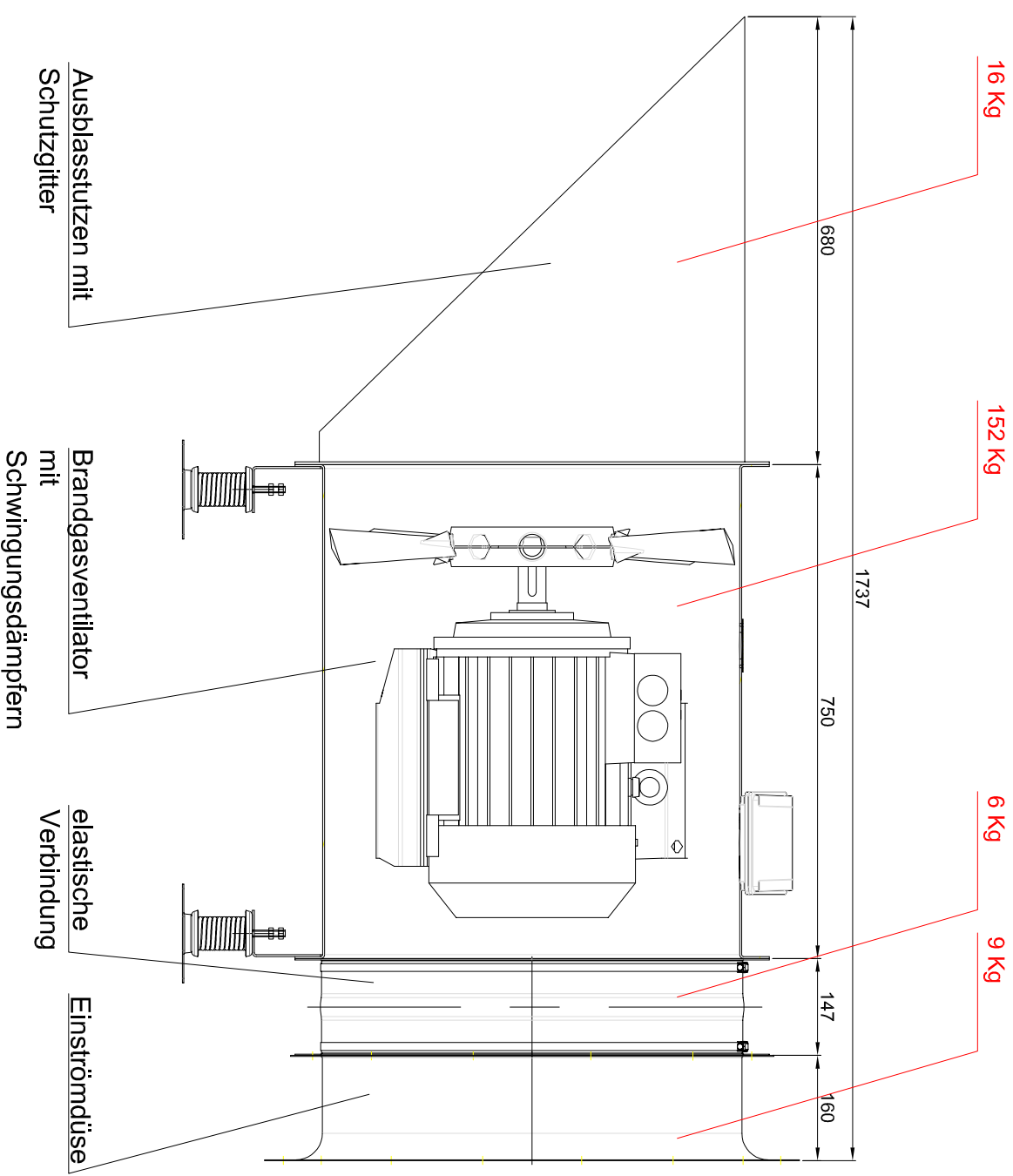

Auslassstutzen mit Schutzgitter

Brandgasventilator mit Schwingungsdämpfern

elastische Verbindung

Einströmdüse

Blattbezeichnung

Brandgasventilator mit Zubehör

Nenngröße 630

24.000 m<sup>3</sup>/h 400 Pa ext.

Blatt-Nr.:

001

Maßstab:

1:20-1:10

entw. Datum Name

gez. 22.03.2018 Kaufhold

gepr. CAD-Nr.:

Format A3